



DC 970

DOOR CONTROL PANEL

OWNER'S MANUAL

Version 1 - 2017



SYMBOL LEGEND



DANGER

THIS INDICATES DANGER TO THE LIFE AND HEALTH OF THE USER IS APPROPRIATE PRECAUTIONS ARE NOT TAKEN



WARNING

THIS WARNS THAT MATERIALS MAY BE DAMAGED IF APPROPRIATE PRECAUTIONS ARE NOT TAKEN



NOTE

IMPORTANT INFORMATION

TECHNICAL DATA

DC 970 DOOR CONTROL PANEL

Dimensions	20" x 20" x 8" (W x H x D)
Mounting	Vertical
Power supply	Configurations available: 110V 1 Phase +/-5%, 60Hz 230V 1 Phase +/-5%, 60Hz 230V 3 Phase +/-5%, 60Hz 460V 3 Phase +/-5%, 60Hz 575V 3 Phase +/-5%, 60Hz
DC 970 Controller supply	24Vac 15VA
External supply 1	24Vac (X1.8, X1.9), Fuse F1 (1A)
External supply 2	24Vdc (24V, GND), 150mA Max. Short circuit protected
Inputs	24Vdc 1 typ. 10mA Signal must be more than 100ms
Relay output	24Vac 1A, Inductive loads require a protected surge suppressors
Temperature	Operating: 32.... 104F Storage: 32.... 122F
Humidity:	93% Max. (non condensing)
Vibration:	Vibration free, mounted on a solid surface
Protection class	Nema 4
Approval	CUL

SAFETY

This control panel has been built in accordance with CUL 508a, EN 12453 Industrial, commercial and garage doors and gates - Safety use of power operated doors - Requirements, and EN 12978 Industrial, commercial and garage doors and gates - Safety devices for power operated doors - Requirements and Test methods. To maintain and ensure safe operation, the user must observe and follow the directions and warnings contained in this manual.



Important Note!

Do not install, operate, or service this DC 970 control panel unless you have read and fully understand the safety practices, warning, and installation instructions contained in this manual.

All electrical work must be performed by qualified personnel in accordance to NEC, local, state, and federal codes.



A separate fused disconnect (usually supplied by others) is required as a means of disconnecting incoming power from the control panel.
The fused disconnect must be installed next to the control panel.
The disconnect must be off, locked, and tagged before wiring can begin.
The DC 970 control panel contains HIGH VOLTAGE.



High Voltage power leads to the operator must be run in a separate conduit from the low voltage control wires.
Installing conduit through the top or sides will void the control panel warranty. Any modifications to the DC 970 control panel without the manufacturer's approval will void the warranty.
Verify all field wiring to ensure terminal connections are tight and correct prior to start-up.

All wiring identified in this manual is for information only. For final electrical connections review the electrical wiring diagram shipped in the control panel.

Do not use if any component appears to be damaged, replace immediately. To aid the wiring and service of all electrical circuits, label all wire ends.

Specified technical data limits are not to be exceeded under any circumstance.



Failure to follow these safety practices may result in personal bodily injury or death.

INSTALLATION OVERVIEW

Once the door is installed according to the mechanical installation guide, follow these steps to correctly install and start-up the DC 970 control system.

Installation	Mount the control panel	page 7
Check	Input Supply	page 8
Installation	Connection overview	page 9
Check	Phase rotation	page 10
Programming	Rapid Limit Adjustment	page 11 & 13

Door can now operate in constant pressure mode.

Installation	Safety	page 19
Programming	Door functions	page 12-18

Door is now functional.

MOUNTING THE CONTROL PANEL

To mount the enclosure, confirm that the surface is flush, solid, and vibration free. The control panel should be mounted 48" above the finished floor for ease of troubleshooting. A separate fused disconnect (supplied by others) must be installed next to the control panel. Area temperature must be between 32 to 105 F.



Important Note!

All electrical work must be performed by qualified personnel in accordance to NEC, local, state and federal.

INPUT SUPPLY

Connect the supply to terminal L1, L2, L3 and GND. Prior to turning on the supply verify that it matches the control panel and operator nameplate, otherwise damage to the equipment may occur. Review electrical wiring diagram shipped in the control panel for connections.



Important Note!

The DC 970 control panel contains high voltage.

CONNECTION OVERVIEW

Basic connections are required for start-up in constant pressure mode. Connect the operator to U,V,W and GND ground terminal blocks. Then connect the digital limit (low voltage) to terminal I through 6.



Important Note!

All electrical works must be performed by qualified personnel in accordance to NEC, local, state and federal codes.

High voltage power leads to the operator must be run in separate conduit from the low voltage wires.

Installing conduits through the top or sides will void the control panel warranty. All wiring identified in this manual is for information only. For final electrical connections review the electrical wiring diagram shipped in the control panel.

PHASE ROTATION

After the input supply voltage and digital limit has been verified and connected, confirm that the phase rotation of the electrical motor is correct. When pressing the open foil button momentarily the door shall move up. When pressing the down foil button momentarily the door shall move down. If this does not occur change the phase rotation.

For all standard three phase operators: Swap U, and W. For FI (GfA frequency inverter) see page 12.

For all single phase operators: Swap U, and ZI



Important Note!

The DC 970 control panel contains high voltage. The disconnect must be off, locked and tagged before any wiring can be changed.

CONTROL PANEL LAYOUT

E-Stop

O/C/S foil buttons

Optional disconnect

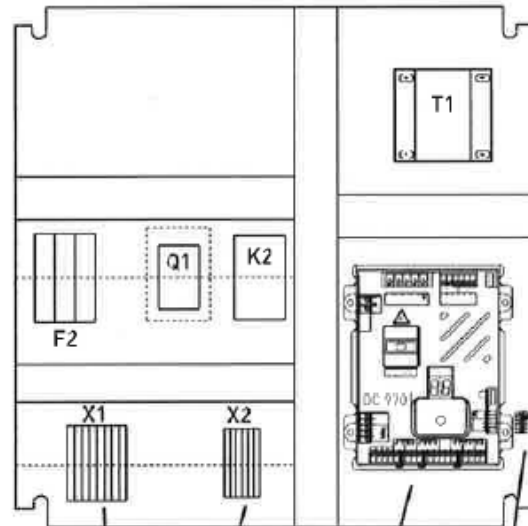
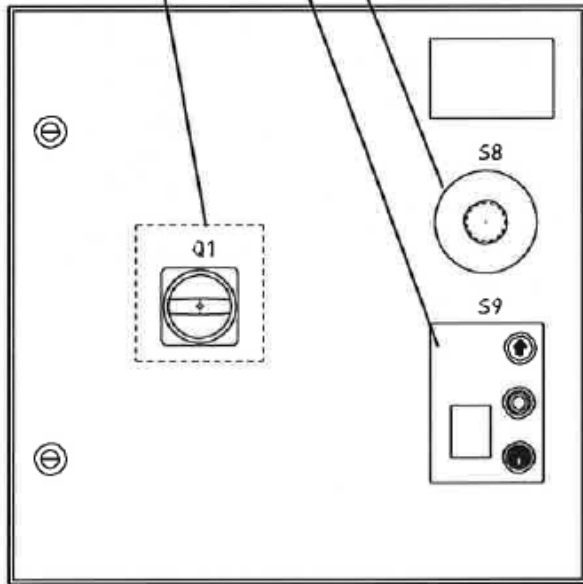

BASIC CONNECTIONS

(Minimum requirement for door operation. Door will now operate in constant pressure mode)

Supply voltage 4C/14AWG min
 Motor connection 4C/14AWG min
 Brake 2C/14AWG min
 (brake connection not required with FI GfA frequency inverter)

Digital limit 6C/18AWG min

ACTIVATION

Pull switch 2C/18AWG min
 Radio controls 4C/18AWG min
 3 Button station 5C/18AWG min

SAFETY

Photocell 5C/18AWG min
 Safety edge Type 1 2C/18AWG min
 Safety edge Type 2 2C/18AWG min
 Safety edge Type 3 3C/18AWG min
 Pass door/Slack cable or Crash switch 2C/18AWG min



Door Specific electrical wiring diagram is shipped in the control panel

Normally closed contact 1.2K ohm

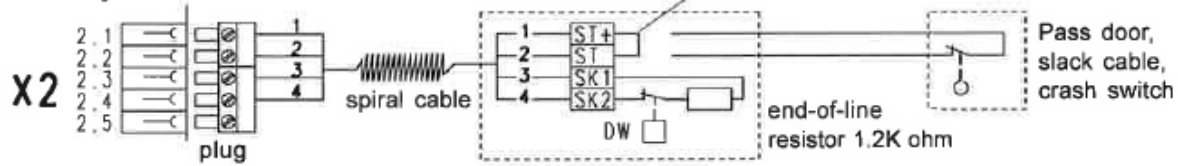

Normally open contact 8.2K ohm

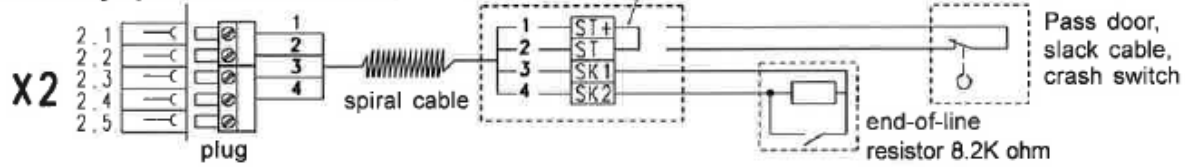

Optical safety edge system

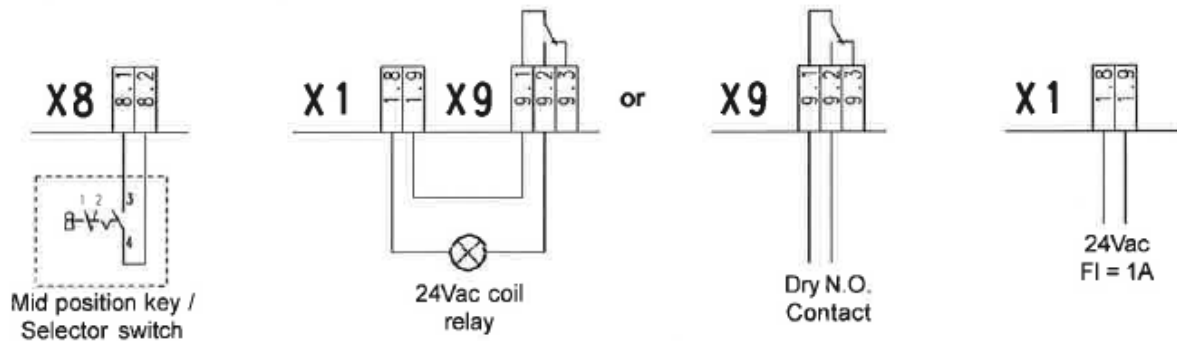
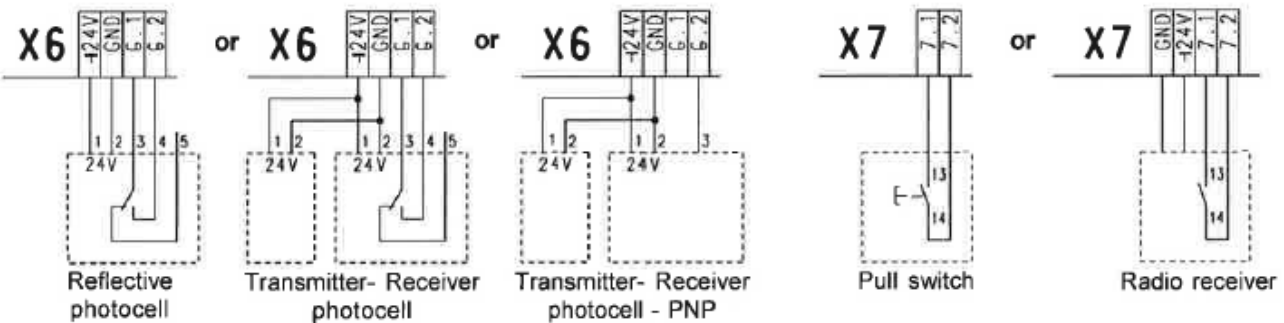
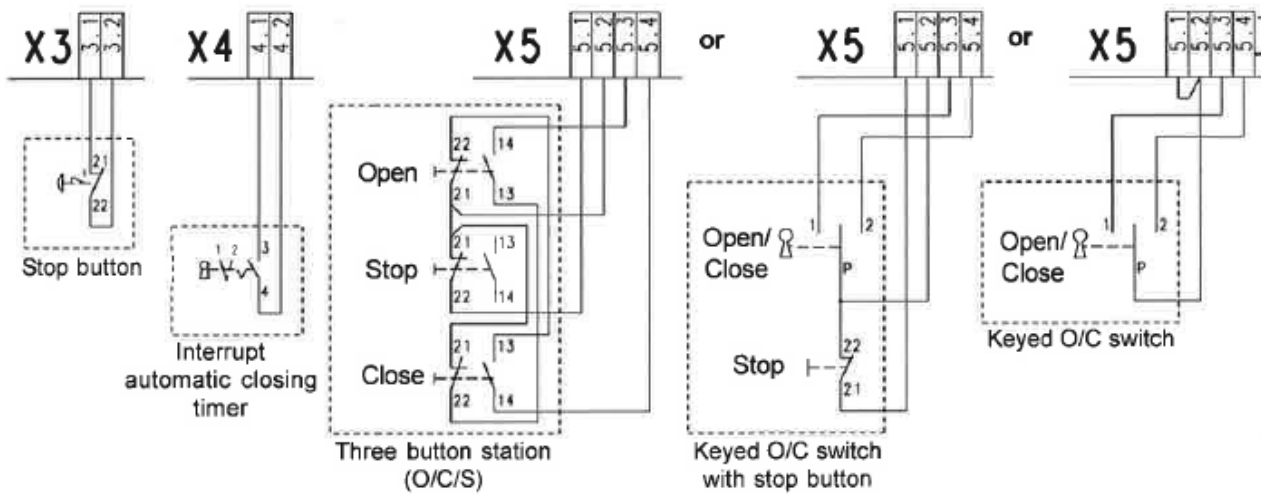
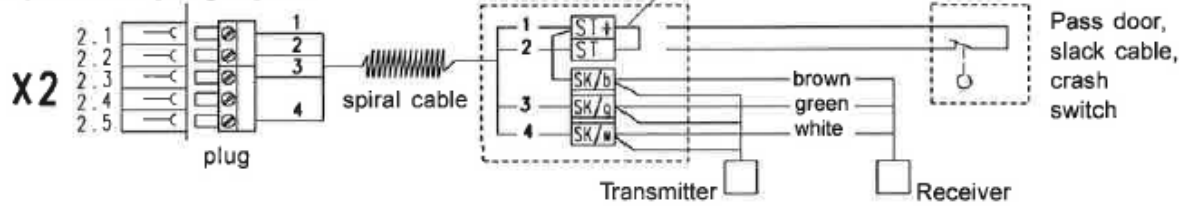

WIRING GUIDE

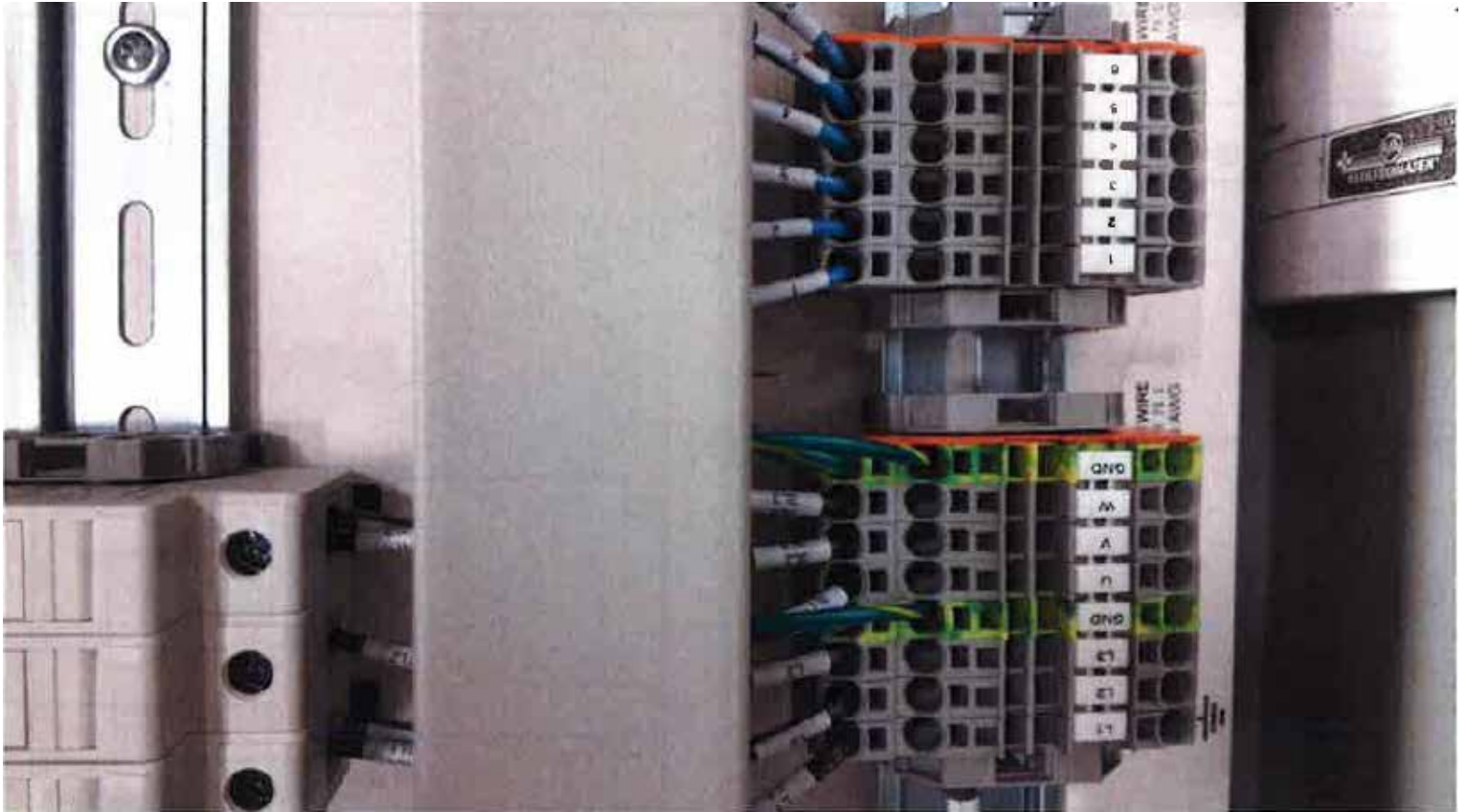

	Terminal Box		Terminal Box	Terminal Motor
	L1		U	U
Connection for Power 460/230V 3 PH	L2	Connection for Motor	V	V
	L3		W	W
	GND		GND	GND
	Terminal Box		Terminal Motor	
Encoder Connection	1			
	2			
	3			
	4			DES
	5			PLUG
	6			

WIRING GUIDE

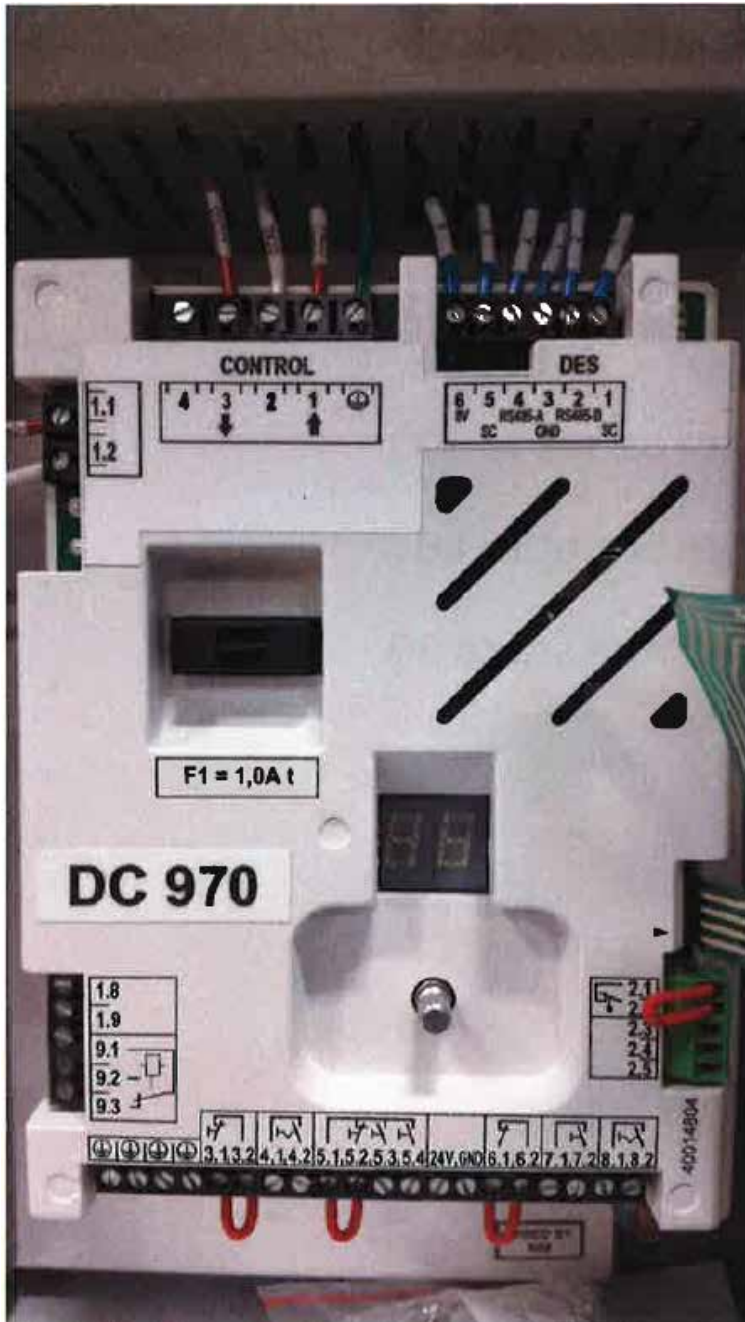

Terminal

Safety Edge (coil cord)

2.3

2.4

Safety Edge (wireless)

Red Wire 24

Black Wire GND

Green Wire 2.3

White Wire 2.4

Allen Bradley Photocell

Blue Wire GND

Brown Wire 24V

Black Wire 6.2

Orange Wire 6.1

Radio Reviewer

24V 24V

GND GND

Relay NO 7.1

Relay COM 7.2

Light Curtain

Blue Wire + Blue Wire 24V

Brown Wire + Brown Wire GND

Black T 6.1 & 6.2

MAXSPEED® MODEL ADJUSTMENTS

On all MaxSpeed® model doors please adjust speed for the following parameters:

4.1 (opening speed)

Door Model Speed

MS350 - full speed parameters can be set to 100

MS500 - full speed parameters can be set to 80

MS1000 - full speed parameters can be set to 30



CONTROL PROGRAMMING

1. Enter programming Mode

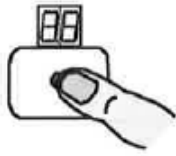

Press selector switch for 3 sec. until **display = 00**

2. Chose program and confirm



Turn selector

and

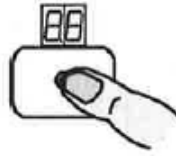

Press selector



3. Adjustment

Setting



Turn selector

Door position

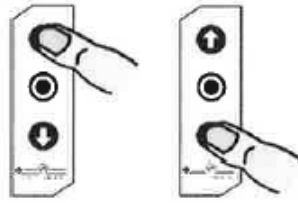

Press foil buttons

or

4. Save

Function

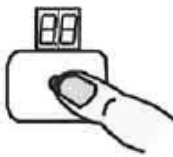

Press selector

Door position

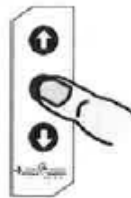

Press stop-button

or

further adjustments

5. Exit programming



Turn selector until display = 00

and

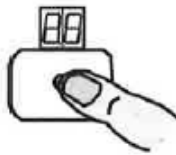

Press selector



RAPID LIMIT ADJUSTMENT

Once the phase rotation has been verified the limits can be adjusted. Fine adjustments can be made with mebus 1.3 or 1.4. Safety limits and FI GfA Frequency inverter slow down limits are automatically adjusted.

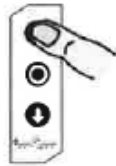
1. Setting the open limit (use control panel foil buttons for adjustment)



Door open

press button to reach the upper limit  

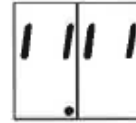

Display blinking

1a. Reversing for FI GfA Frequency inverter only (for all others see page 8)



To reverse the motor rotation keep both buttons pressed for three seconds until the display changes



Display blinking



Display changes

2. Save the open limit



Press stop-button for 3 sec. until the display changes



Display changes



The OPEN limit can only be saved after the door travels for at least one second in the open direction.

3. Setting the close limit (use control panel foil buttons for adjustment)

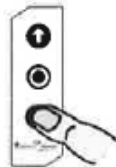

Door close

press button to reach lower the limit  

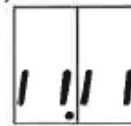

Display blinking

4. Save the close limit



Press stop-button for 3 sec. until the display changes





































Display changes





Rapid limit adjustment is complete

The door open and close buttons will operate in constant pressure mode. To change operating mode see menu 0.1 "Door Function" (to change operating mode a safety monitored device must be connected). To re-adjust open limit see menu 1.1 or 1.3, for close limit see menu 1.2 or 1.4. To reset and start over see menu 9.5





MENU

2. Choose program and confirm	3. Adjustment	4. Save
Operating mode - Menu 0.1		
 Door function	  Constant pressure OPEN Constant pressure CLOSE  Impulse OPEN Constant pressure CLOSE  Impulse OPEN Impulse CLOSE  Not available (Do not set to 4)	 Press selector
Door position - Menu 1.1 to 1.7		
 Open limit coarse adjustment	  Move door up or down	 Press stop Button
 Close limit coarse adjustment	  Move door up or down	 Press stop Button
 Open limit fine adjustment	  Open limit can change without door movement using +/-	 Press selector
 Close limit fine adjustment	  Close limit can change without door movement using +/-	 Press selector
 Pre-limit safety edge fine adjustment (See Menu 2.1)	  Pre-limit safety edge can change using +/-	 Press selector
 Mid limit setting	  Move to mid position	 Press stop Button
 Output relay position setting (See Menu 2.5)	  Move to output relay position	 Press stop Button



















MENU

2. Choose program and confirm	3. Adjustment	4. Save
Functions - Menu 2.1 to 2.6		
21 Safety edge function during last 2" of travel (See Menu 1.5)	 <ul style="list-style-type: none"> <input type="checkbox"/> 0 Safety edge stops if activated <active> <input type="checkbox"/> 2 Safety continues to the bottom limit if activated <ignored> <input type="checkbox"/> 3 If safety edge is activated, bottom limit is automatically adjusted <input type="checkbox"/> 4 Not available (Do not set to 4) 	<input type="radio"/> Press selector
22 Overrun correction	 <ul style="list-style-type: none"> <input type="checkbox"/> 0 OFF <input type="checkbox"/> 1 ON 	<input type="radio"/> Press selector
23 Automatic closing	 <ul style="list-style-type: none"> <input type="checkbox"/> 00 Adjustable between 1 - 240 sec. 0 = OFF 	<input type="radio"/> Press selector
24 Photocell close after passing	 <ul style="list-style-type: none"> <input type="checkbox"/> 0 OFF <input type="checkbox"/> 1 Immediately closes after 3sec delay <input type="checkbox"/> 2 Vehicle recognition, closes when activated for more than 1,5 sec. 	<input type="radio"/> Press selector
25 Relay function	 <ul style="list-style-type: none"> <input type="checkbox"/> 0 OFF <input type="checkbox"/> 1 Output contact impulse (See Menu 1.7 for position adjustment, and page 10 for wiring) <input type="checkbox"/> 2 Continuous output contact (See Menu 1.7 for position adjustment and page 10 for wiring) <input type="checkbox"/> 3 Output for lights, flashing 3 sec. prior to opening, closing, and continuous contact during travel (See page 10 for wiring) <input type="checkbox"/> 4 Output for lights, flashing 3 sec. prior to closing, and continuous contact during travel (See page 10 for wiring) <input type="checkbox"/> 5 Output for lights, on 3 sec. prior to opening, closing, and continuous contact during travel (See page 10 for wiring) <input type="checkbox"/> 6 Output for lights, on 3 sec. prior to closing, and continuous contact during travel (See page 10 for wiring) 	<input type="radio"/> Press selector

MENU

2. Chose program and confirm	3. Adjustment	4. Save
Functions - Menu 2.1 to 2.6		
26 Special activation function (X7): Pull switch / Single button radio remote control only	 <input type="checkbox"/> Impulse to Open or Close, impulse during closing door stops and re-opens <input type="checkbox"/> Commands O/C/S <input type="checkbox"/> Open→Stop→Close→Stop→Open	<input type="radio"/> Press selector
Safety functions - Menu 3.1, 3.2, 3.4, 3.8		
31 Not Available (Do not adjust)	 <input type="checkbox"/> OFF <input type="checkbox"/> Not available (Do not set to 1) <input type="checkbox"/> Not available (Do not set to 2)	<input type="radio"/> Press selector
32 Photocell interrupt function	 <input type="checkbox"/> OFF <input type="checkbox"/> ON (See page 22 for details)	<input type="radio"/> Press selector
34 Door auxiliary switch function	 <input type="checkbox"/> Slack cable / Pass door <input type="checkbox"/> Crash detector (NC Contact) <input type="checkbox"/> Crash detector (NO Contact) (See page 18 for details)	<input type="radio"/> Press selector
38 Safety edge reverse delay	 <input type="checkbox"/> Normal <input type="checkbox"/> Reduce delay <input type="checkbox"/> Increase delay Three adjustment levels are available	<input type="radio"/> Press selector







MENU

2. Choose program and confirm	3. Adjustment	4. Save
Settings only for FI GfA Frequency inverter - Menu 4.1 to 4.9		
41 OPENING speed	  Output speed rpm	<input type="radio"/> Press selector
42 CLOSING speed	  Output speed rpm	<input type="radio"/> Press selector
43 HIGHER CLOSING speed	  Increase closing speed above 8.5ft 0 = OFF (To set position adjust Menu 4.4)	<input type="radio"/> Press selector
44 Changeover position CLOSING speed	  Changeover position from higher to lower speed. Warning! Last 8.5ft of closing travel must be at lower speed. (To set Menu 4.3 must be 1)	<input checked="" type="radio"/> Press stop Button
45 OPENING acceleration	  FI Setting from 0,5 – 3,0 sec in steps of 0.1s	<input type="radio"/> Press selector
46 CLOSING acceleration	  FI Setting from 0,5 – 3,0 sec in steps of 0.1s	<input type="radio"/> Press selector
47 OPENING deceleration	  FI Setting from 0,5 – 3,0 sec in steps of 0.1s	<input type="radio"/> Press selector
48 CLOSING deceleration	  FI Setting from 0,5 – 3,0 sec in steps of 0.1s	<input type="radio"/> Press selector
49 Creep-speed (Jog Speed)	  Output speed rpm	<input type="radio"/> Press selector









The settings for the output OPENING and CLOSING speeds correspond to the real RPM output of the operator. The speed directly affects the operating forces of the door. Therefore the “maximum and minimum” preset speeds cannot be exceeded.

MENU

2. Chose program and confirm		3. Adjustment		4. Save	
Maintenance cycle counter - Menu 8.5, 8.6					
89	Counter Service (CS) maintenance	 00	01-99 correspond from 1.000 up to 99.000. "CS" counts down for service.		Press selector
88	Maintenance due CS=0	 01	"CS" is displayed, clear by setting a new interval in Menu 8.5		Press selector
		 02	"CS" is displayed and function changes to constant pressure mode. Clear by setting a new interval in Menu 8.5		
		 03	Same as above, but "CS" can also be reset for 500 more cycles by the enduser. Press the stop button for 3 sec. to activate.		

MEMORY CHECK Menu 9.1,9.2,9.3,9.4

2. Chose program and confirm		Displayed	
91	Info: 7- digit cycle counter  Press selector	 M HT ZT T H Z E	The cycles would be displayed one at a time as follow. M = 1.000.000 H = 100 HT = 100.000 Z = 10 ZT = 10.000 E = 1 T = 1.000
92	Info: Last 2 faults  Press selector		Last 2 faults would be alternately displayed.
93	Info: Program changes 7- digit  Press selector	 M HT ZT T H Z E	The Number of program changes would be displayed one at a time as follow. M = 1.000.000 H = 100 HT = 100.000 Z = 10 ZT = 10.000 E = 1 T = 1.000
94	Info: Program version  Press selector		Program version will be displayed

RESET Menu 9.5

2. Chose program and confirm	3. Adjustment		4. Save
9.5 RESETS all except cycle counter (Menu 9.1) and Program change counter (Menu 9.3)	<input type="radio"/> <input type="radio"/>	. Reset	<input checked="" type="radio"/> Press stop button 3 sec.

SAFETY

Door auxiliary switch X2

This is a door mounted switch that is connected via the spiral cable to the control panel. This switch can be used and programmed as of two functions.

Menu 3.4 Door auxiliary switch

Function	Reaction following the activation	
Slack cable / Pass door	Contact open: Contact closed:	Door stops Door ready to run.
Crash detector	Contact momentarily opened: Contact closed:	Door will stop immediately. The door will then only function in constant pressure mode. The door is reset when the control panel mounted "stop" foil button is pressed for a minimum of three seconds. (If using a GfA frequency inverter the door will move in creep speed).

If a passdoor, slack cable, or crash switch contact is used, remove jumper and connect to terminal X2.1, X2.2

SAFETY

Primary monitored safety edge system **X2**

The controller recognizes 3 different safety edges systems. By using a four conductor spiral cable will allow any combination of safety edge systems and door auxiliary switch functions.

Type 1: Normally closed edge with a 1.2K ohm resistor

This system is made for pressure switches with a normally closed contact in series with an end-of-line 1.2K +/- 5% 0,25W resistor. By compressing the rubber profile, a pressure is transmitted through the plastic hose to the air-wave pressure switch which momentarily opens the 1.2K ohm circuit to signal an activation. In a normal state a constant 1.2K ohm circuit is maintained.

Pressure edge test

When a door is closing, a pressure must be sensed by contact with the finished floor within two seconds of the last 2" of travel to confirm the safety edge test. If the pressure switch does not become activated during this time, the door safety edge test failed and shows a 2.8 fault. Door will only close in constant pressure mode.



To verify edge type and adjustment procedures see door owners manual.

Type 2: Normally open edge with a 8.2K ohm resistor

This system is made for electrical safety edges with an end-of-line 8.2K +/- 5% 0,25W resistor. The resistor must be connected parallel with the safety edge end. By compressing the rubber profile, a momentary short circuit is created across the 8.2K ohm resistor to activate the safety edge. In a normal state a constant 8.2K ohm circuit is maintained. This is a continually monitored system.



To verify edge type see door owners manual.

SAFETY

Type 3: Optical safety edge (Vitector)

This system incorporates an infrared sensor for optically sensing edges. By compressing the rubber profile, the blocked beam will activate the edge. This is a continually monitored system.



To verify edge type see door owners manual.



Important Note!

Consider EN 12978 for Industrial, commercial and garage doors and gates - Safety devices for power operated doors - Requirements and Test methods.

Important note!

When using a safety edge system, verify that when the safety edge is activated the door stops and reverses to the open position.

Safety edge function during last 2” of travel - Menu 2.1

Function	Reaction following an activation
Active safety edge	Will stop between the floor and 2” and will not reverse
De-activated safety edge	No reaction, door continues to the bottom limit
Active safety edge+ downward automatic floor adjustment	Stops and automatically re-adjusts the bottom limit with the next movement

The function ‘Auto ground adjustment’ is used for doors with a lifting cable such as a sectional door or vertical lift-gate. Automatic correction of a slack cable or a change of ground height up to 1-2” is possible. The slack cable switch will still be monitored.



Important Note!

The automatic ground adjustment Menu 2.1 setting 3 only operates with:

Type 2: Normally open edge with a 8.2K ohm resistor or **Type 3:** Optical safety edge (Vitector) and must be adjusted to contact the finish floor each cycle.

Important note!

When the safety edge has been activated twice the automatic closing feature will be interrupted and fault F2.2 will be displayed.

To reset the fault press the control panel foil button **0** so that the door travels down to the closed position.

SAFETY

Pass door I slack cable switch input (X2 connection)

The pedestrian pass door or cable slack switch is connected to terminal X2.1, X2.2 and is continuously monitored by the control panel. If the pedestrian pass door or slack cable circuit becomes open the door stops and will not operate.

DESCRIPTION OF FUNCTION

Stop button (X3 connection)

Stop button can stop door movement at any time.



Important Note!

This is a momentary stop button. Activators can re-activate door travel. This is not a latched emergency stop circuit.

Key switch interrupt automatic closing - Menu 2.4 (X4 connection)

The automatic closing time can be interrupted with a maintained normally closed contact.

Internal and external O/C/S buttons I Key switch (XS connection)

Control panel foil and external push buttons operate separately from each other. The control panel foil buttons always have priority when pressed at same time.

Automatic Closing - Menu 2.3

Close time delay is adjusted between 1- 240 sec.



Important Note!

In the open position timer can be reset by pressing the stop button, or initiating another open command.

Close after passing - Menu 2.4

This feature will keep the door open until the photocell is interrupted and re-established. The door closes after a fixed 3 second pre-warning .

Photocell (XS connection)

An external non failsafe photocell can be connected to the controller. A 24Vdc supply for the photocell is available.



Important Note!

The 24Vdc power supply load may not exceed 150mA.

DESCRIPTION OF FUNCTION

The Photocell is to be connected in a normally closed operating mode. If the photocell is interrupted, or if it malfunctions, the electrical contact will become open and cause the following:

Door Position	Interrupted photocell beam
Door closed	No reaction, remains open
Door opening	No reaction, remains closed
Open limit *) without timer active	No reaction, remains open
Open limit *) with active timer	Resets the open timer for automatic closing
Open limit *) with active timer and close after passing	Close timer stops, once the photocell is interrupted and re- established. Door closes after 3 sec
Door closing	Stops and opens to the open position *)

*) or to the mid position when the key or selector switch contact (X8.1, X8.2) is closed.

Interruption of the photocell function - Menu 3.2

This function is to ignore the photocell below a specific position. An example for such a requirement would be a spiral cable breaking the photocell near the closed position. To learn the switching position the door requires 2 full OPEN and CLOSE cycles. During the close cycle the photocell shall be broken two times consecutively at the same position. The position is then memorized, and the photocell is ignored below this setting. To activate set Menu 3.2 adjustment to 1.

After the program was selected a 2 appears on the left display (see fig.)



With the first interruption of the photocell the display changes to 1

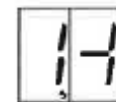

and after the second interruption it changes to CLOSE (see fig.); the function is activated.



If the adjustment was not successful a 2 will be displayed for a short period. If so the last switching position will be the first new position and a 1 is displayed. The door must travel a new cycle so the second position will be memorized. After programming, setting must be tested.



Important Note!

While programming this function, the photocell will not reverse to open.

DESCRIPTION OF FUNCTION

Pull switch I Radio control - Menu 2.6 (X7 connection)

It is possible to connect a pull switch or a radio receiver's dry contact to input X7.1 and X7.2 and activate the single open/close function.

The following is the sequence of operation for the single input activator:

Door position	Door operation
Closed	Opens to fully open or mid limit position
Opening	Continues to open (no change)
Open	Door closes to fully closed position
Mid limit position (if set)	Door closes to fully closed position
Moving downwards	Door STOPS and moves BACK UP to the open Position*)

See functions Menu 2.6 Adjustment 0.2 O/C/S function

*) or to the mid limit position when the key or selector switch contact (XB.1, XB.2) is closed.

Mid limit position - Menu 1.6 (XS connection)

Mid limit can be activated or de-activated by connecting a key or selector switch to XB.1 and XB.2. With an open contact across XB the door will travel to the open limit. With a closed contact the door will travel to the mid limit position. Menu 1.6 is used to set the mid limit position.

Relay function - Menu 2.5 (X9 connection)

The output relay function can be configured as 1 of the 6 settings found in Menu 2.5.

See page 10 for wiring.



Important Note!

Only one programmable relay is available, for single function.

To activate the output relay function at a specific height, Menu 1.7 must be set.

DESCRIPTION OF FUNCTION

Overrun correction - Menu 2.2

The stopping position of the door can be affected by various factors such as temperature and cable stretch. To have the same stopping position the overrun correction can be activated with Menu 2.2. Adjustment 0.0=OFF, 0.1=ON.



Important Note!

This can only operate with a continuously self monitored safety edge type 2 or type 3 system, and must contact the finished floor every cycle. See X2 description.

Important note!

Great variations of temperature during a time when the door is not in use, could cause a position variation of about 0.375". This will re-adjust automatically after a closing cycle.

Maintenance cycle counter - Menu 8.5

Adjustable maintenance cycle counter makes it possible to pre-adjust a max. number of cycles until maintenance is due.

The maintenance cycles can be adjusted from 1.000 up to 99.000; in steps of 1.000 cycles. Three different door functions in **Menu 8.6** are available once the maintenance cycle count has been reached.

A cycle is considered when the door reaches the top limit.

Upon maintenance, the cycle counter then could be re-adjusted to a new maintenance period with a new door function.

Short circuit I overload monitor

The DC 970 control panel includes 2 supplies for external devices.

24Vac, 1Amax.















24Vdc, 150mA max.

A 24Vdc short circuit turns the display off.

DISPLAY CODES / FAULT CODES

The DC 970 can display up to three different status conditions one after another. Each status is displayed with a letter and a number. The letter and the number are flashing alternately.

FAULT = F and a command = E.

Report	Description	Solution
	Door auxiliary switch, pass door or slack cable contact is open	Circuit should be closed. Check for proper operation of the pedestrian pass door or slack cable contact. Verify whether the electrical cable is open.
	Chain hoist engaged or motor-winding thermal switch active	Check chain hoist green lever or whether the drive unit thermal switch is active.
	Stop button activated	Stop circuit should be closed. Check if the stop button is activated. Verify whether the electrical cable is open.
	Door auxiliary switch, circuit failure, voltage is less than 24Vdc	Verify that the voltage between 24V and GND is 24V dc. Check for proper connections of the pedestrian pass door or slack cable switch. To reset the fault, open and close the pass door switch or switch OFF and ON the main disconnect.
	Failure input pass door (X 2.1 - X 2.2)	To reset the fault, open and close the pass door switch or switch main disconnect OFF and ON. If necessary replace the control panel.
	Safety edge not recognized	Check that the safety edge is connected correctly and verify that the correct type has been selected in the program.
	Photocell activated	Check photocell alignment and it's proper installation. Verify whether the electrical cable is open.
	Safety edge activated for two consecutive cycles	Check if there is an obstacle in the opening. Verify whether the electrical cable is open or if a short exists.
	Safety edge 8.2K activated	Check the safety edge and verify whether a short exists in the electrical cable.
	Safety edge 8.2K defective	Check the safety edge resistance and verify that the correct safety edge type has been selected in the program.
	Safety edge 1.2K activated	Check the safety edge is activated and verify whether a short exists in the electrical cable.
	Safety edge 1.2K defective	Check the safety edge resistance and verify whether the electrical cable is open.
	Safety edge 1.2K pneumatic system TEST failure	Check that the correct safety edge type has been selected in the program and that testing in the lower door position is correct.
	Optical safety edge activated or defective	Check that the correct safety edge type has been selected in the program and verify whether the electrical cable is open.



DISPLAY CODES / FAULT CODES

Report	Description	Solution
A 30	Limits not adjusted	Adjust limits
31	Open safety limit activated	Turn OFF the disconnect and move the door down with the hoist or crank until the cam is off the safety limit. Open limit may need to be re-adjusted.
32	Close safety limit activated	Turn OFF the disconnect and move the door up with the hoist or crank until the cam is off the safety limit. Close limit may need to be re-adjusted.
41	Door load monitor has activated	Check the door mechanism for tightness.
45	Door auxiliary switch: function Crash detector activated.	Check if the switch is properly installed or is activated. After repair: Press Stop button for a minimum of 3 sec to reset.
51	ROM (Read only memory) – Fault	To reset the fault, open and close the pass door switch or switch main disconnect OFF and ON.
52	Internal fault report	To reset the fault, open and close the pass door switch or switch main disconnect OFF and ON.
53	RAM (Random access memory) – Fault	To reset the fault, open and close the pass door switch or switch main disconnect OFF and ON.
54	Internal control fault	To reset the fault, open and close the pass door switch or switch main disconnect OFF and ON.
55	DES (Digital limit) – no response	Check electronic limit DES connection. To reset the fault, open and close the pass door switch or switch main disconnect OFF and ON. If necessary replace the control panel or digital limit (DES).
56	Drive unit does not operate	Check the door mechanics. Verify input power and fuses. Check that the limit shaft does rotate. Verify phase rotation.
57	Phase rotation failure	Check supply phase.
58	Improper movement when door is stopped, e.g. worn brake or incorrect inverter signal.	The fault will reset with the next door command. Check function of the brake and replace if necessary. Otherwise if the fault re-appears replace the frequency inverter.
59	The drive does not respond to the given command e.g. torque overload or a frequency inverter failure.	The fault will reset with the next door command. Check drive load and supply voltage. If this is correct and if the fault re-appears replace the frequency inverter.

DISPLAY CODES / FAULT CODES





Report	Description	Solution
F 61	Over speed closing	To reset the fault, switch main disconnect OFF and ON. If the fault re-appears replace the frequency inverter.
62	Internal frequency inverter communication fault.	To reset the fault, switch main disconnect OFF and ON. If the fault re-appears replace the frequency inverter.
63	Insufficient supply or a frequency inverter fault.	The fault will reset with the next door command. Verify supply voltage, fusing, acceleration and deceleration settings.
64	Circuit overload	The fault will reset with the next door command. Increase acceleration and or deceleration settings.
65	Exceeding the frequency inverter temperature e.g. load, high cycles.	The fault will reset with the next door command. Reduce load, and/or cycles.
66	Exceeding motor current or failure of the frequency inverter.	Check the door mechanism, weight and friction. The fault will reset with the next door command. If the fault re-appears replace the frequency inverter.
67	Brake fault (Frequency inverter)	Check the brake, replace if required. If the fault re-appears replace the frequency inverter.
69	Frequency inverter group status	The fault will reset with the next door command. If the fault re-appears replace the frequency inverter.

OPERATING STATUS DISPLAY

Report	Command description
	Open command
	Stop command
	Close command

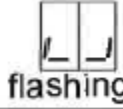
	Maintenance due (Counter service)
---	-----------------------------------

	Display off = short circuit or overload with the 24Vdc supply. Check connection between terminal 24V and GND terminal on the DC 970.
---	---

Report	Status
	Opening
	Closing
	Door between set limits
	Door at upper limit
	Door at lower limit

DECLARATION OF INCORPORATION

in the terms of Machinery Directive 2006/42/EC
for partly completed machinery, Appendix II Part B



GfA-Gesellschaft für Antriebstechnik
Dr.-Ing. Hammann GmbH & Co. KG
Wiesenstraße 81
40549 Düsseldorf

Declaration of conformance in terms of EMC Directive 2004/108/EC

Telefon: +49 (0) 211-500 90 0
Telefax: +49 (0) 211-500 90 90
www.gfa-elektromaten.de

We, the
GfA - Gesellschaft für Antriebstechnik
hereby declare that the following products are conform with the
above EC Guidelines and are only intended for installation in door equipment.

Door control panel DC 970

Standards applied

- DIN EN 12453** Doors - safety in use of power operated doors
- DIN EN 12978** Industrial, commercial and garage doors and gates -
Safety devices for power operated doors - Requirements and Test methods
- DIN EN 60335-1** Safety of household and similar electrical appliances
Purposes - Part 1 : General requirements
- DIN EN 61000-6-2** Electromagnetic compatibility (EMC) Part 6-2
Generic standard – Emission standard for industrial environments
- DIN EN 61000-6-3** Electromagnetic compatibility (EMC) Part 6-3
Generic standard – Emission standard for residential,
commercial and light-industrial environments

We undertake to transmit in response to a reasoned request by the appropriate regulatory
authorities the special documents
on the partly completed machinery.

Authorised representative for the compilation of the relevant technical documents

(internal EU address)

Dipl. Ing. Bernd Synowsky
Documentation representative

Incomplete machines within the meaning of the EC Directive 2006/42/EC shall only be intended
to be integrated into other machines (or into other incomplete machines/systems) or to be
assembled with them to form a complete machine within the sense of the Directive. Therefore,
this product cannot be commissioned before it is determined that the entire machine/system to
which it was integrated shall comply with the provisions of the Machinery Directive indicated
above.

Düsseldorf, 01. 01. 2010

Stephan Kleine
CEO

Signature

FUNCTION OVERVIEW

DC 970 Control panel with DES digital limit

7- Segment led display showing

Program settings
Display Command<>Info<>Fault

Mains supply

Configurations available:
110V 1 Phase +/-5%, 60Hz
230V 1 Phase +/-5%, 60Hz
230V 3 Phase +/-5%, 60Hz
460V 3 Phase +/-5%, 60Hz
575V 3 Phase +/-5%, 60Hz

Door operating modes

Constant pressure open and close (without a monitored safety edge connected)
Impulse open and constant pressure close (without a monitored safety edge connected)
Impulse open and close (with a monitored safety edge connected)
Automatic open and delay close (with a monitored safety edge connected)

Integrated safety edge systems

8.2K normally open contact
1.2K normally close contact
Optical safety edge system (System Vitector)

Automatic close feature

Programmable from 1 to ...240 Sec. max.
3 sec close after passing function
Can be interrupted by a separate switch

Supply for external devices

24Vac, 1A Max.
24Vdc, 150mA Max.

Electronic DES limit (digital limit)

Plug for spiral cable (monitored safety edge and auxiliary door contact)

Control panel mounted OPEN | CLOSE | STOP buttons

Additional terminals for:

Stop buttons
External three button station (O/C/S)
Reversing photocell with adjustable delay closing
One channel - impulse functions e. g. Pull switch or radio control for O/C/S function
1 potential free programmable relay output either NC or NO
Key/Selector switch for mid limit position